

# Verbindungselemente

## Verschraubungen aus Metall

### Baureihe C10

Seite 207



### Baureihe C10

Seite 207



### Baureihe C23

Seite 207



### Baureihe C21

Seite 208



### Baureihe C20

Seite 208



### Baureihe C20

Seite 208



### Baureihe C14

Seite 208



### Baureihe C14L

Seite 208



### Baureihe C13

Seite 209



### Baureihe C13L

Seite 209



### Baureihe C30

Seite 209



### Baureihe C19

Seite 209



### Baureihe C18

Seite 210



### Baureihe C50

Seite 210



### Baureihe C60

Seite 210



### Baureihe C70

Seite 210



**Baureihe C26**

Seite 211



**Baureihe C80**

Seite 211



**Baureihe C38**

Seite 211



**Baureihe C39**

Seite 211



**Baureihe CDB**

Seite 211



Verschraubungen aus Metall

Technische Anweisungen

**Werkstoffe:** Messing vernickelt  
**Höchstbetriebsdruck:** 18 bar  
**Betriebstemperatur:** -10°C bis +80°C

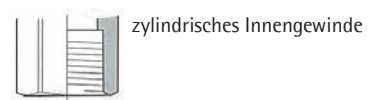
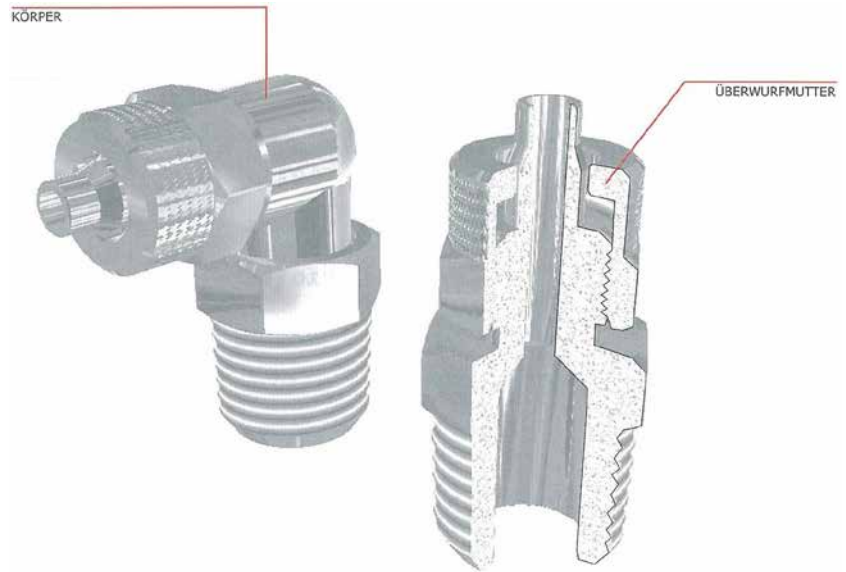

Verschraubungen aus Metall

Gerade Einschraubverschraubung, konisches Gewinde

Baureihe C10

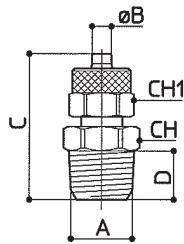

Typ	A	B	C	D	CH	CH1
C10805	1/8	5/3	26	8	12	9
C10806	1/8	6/4	27,5	8	12	12
C10406	1/4	6/4	31	11	14	12
C10306	3/8	6/4	31,5	11	17	12
C10808	1/8	8/6	28	8	13	14
C10408	1/4	8/6	32	11	14	14
C10308	3/8	8/6	31,5	11	17	14
C10810	1/8	10/8	29,5	8	14	16
C10410	1/4	10/8	32,5	11	14	16
C10310	3/8	10/8	33	11	17	16
C10210	1/2	10/8	38	14	22	16
C10412	1/4	12/10	34	11	17	19
C10312	3/8	12/10	34,5	11	17	19
C10212	1/2	12/10	38	14	22	19
C10215	1/2	15/12,5	39,5	14	22	22

Gerade Einschraubverschraubung

Baureihe C10

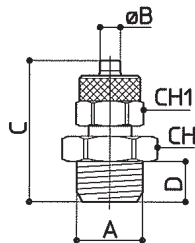

Typ	A	B	C	D	CH	CH1
C10505	M5	5/3	20,5	4	8	9
C108059	1/8	5/3	23	6	14	8
C10605	M5	6/4	21,5	4	8	9
C108069	1/8	6/4	25,5	6	14	12
C104069	1/4	6/4	28	8	17	12
C103069	3/8	6/4	29	9	19	12
C108089	1/8	8/6	26	6	14	14
C104089	1/4	8/6	29	8	17	14
C103089	3/8	8/6	30,5	9	19	14
C108109	1/8	10/8	27,5	6	14	16
C104109	1/4	10/8	29,5	8	17	16
C103109	3/8	10/8	32	9	19	16
C102109	1/2	10/8	35,5	10	24	16
C103129	3/8	12/10	32,5	9	19	19
C102129	1/2	12/10	34	10	24	19
C102159	1/2	15/12,5	35,5	10	24	22

Gerade Aufsraubverschraubung

Baureihe C23

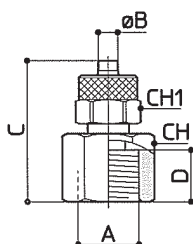

Typ	A	B	C	D	CH	CH1
C23805	1/8	5/3	22,5	8	4	8
C23806	1/8	6/4	27	8	14	12
C23406	1/4	6/4	29	11	17	12
C23306	3/8	6/4	29,5	11,5	20	12
C23808	1/8	8/6	28	8	14	14
C23408	1/4	8/6	29	11	17	14
C23308	3/8	8/6	29,5	11,5	20	14
C23810	1/8	10/8	26,5	8	14	16
C23410	1/4	10/8	30,5	11	17	16
C23310	3/8	10/8	31	11,5	20	16
C23210	1/2	10/8	34,5	14	24	16
C23312	3/8	12/10	32,5	11,5	20	18

Baureihe C21

Winkel-Einschraubverschraubung, konisches Gewinde

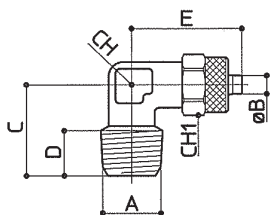

Typ	A	B	C	D	E	CH	CH1
C21805	1/8	5/3	18,5	8	20	9	9
C21806	1/8	6/4	18,5	8	22	9	12
C21406	1/4	6/4	21	11	24	10	12
C21306	3/8	6/4	22	11	25,5	11	12
C21808	1/8	8/6	19	8	24	10	14
C21408	1/4	8/6	21	11	24	10	14
C21308	3/8	8/6	22	11	25,5	11	14
C21810	1/8	10/8	19	8	25,5	11	16
C21410	1/4	10/8	22	11	26	11	16
C21310	3/8	10/8	22	11	26	11	16
C21210	1/2	10/8	29	14	30	17	16
C21412	1/4	12/10	24	11	28,5	13	19
C21312	3/8	12/10	24	11	28,5	13	19
C21212	1/2	12/10	29	14	30	17	19
C21215	1/2	15/12,5	28	14	34	17	22

Baureihe C20

Winkel-Einschraubverschraubung drehbar, konisches Gewinde

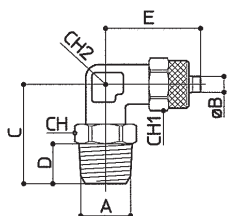

Typ	A	B	C	D	E	CH	CH1	CH2
C20806	1/8	6/4	25	8	22	12	12	9
C20406	1/4	6/4	29	11	24	14	12	10
C20808	1/8	8/6	25	8	24	12	14	10
C20408	1/4	8/6	29	11	24	14	14	10
C20410	1/4	10/8	29	11	26	14	16	11
C20310	3/8	10/8	29	11	26	17	16	11

Baureihe C20

Winkel-Einschraubverschraubung drehbar

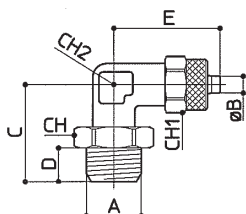

Typ	A	B	C	D	E	CH	CH1	CH2
C21505	M5	5/3	13	4	21,5		9	
C21506	M5	6/4	13	4	20		9	
C208069	1/8	6/4	22,5	6	22,5	14	12	8
C204069	1/4	6/4	25	8	23,5	17	12	10
C208089	1/8	8/6	22,5	6	23,5	14	14	10
C204089	1/4	8/6	25	8	23,5	17	14	10
C204109	1/4	10/8	22,5	8	25,5	17	16	11

Baureihe C14

Winkel-Einschraubanschluss drehbar mit Innensechskant

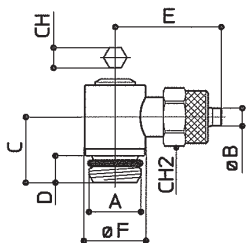

Typ	A	B	C	D	E	F	CH	CH2
C148047	1/8	5/3	13,5	5	22,5	14	4	8
C144047	1/4	5/3	15	6	24	14,3	4	12
C148067	1/8	6/4	13,5	5	26	14	4	12
C144067	1/4	6/4	15	6	24	14,3	4	14
C148087	1/8	8/6	13,5	5	26	14	4	14
C144087	1/4	8/6	15	6	28	14,3	4	16

Baureihe C14L

Winkel-Einschraubanschluss drehbar mit Innensechskant, lang

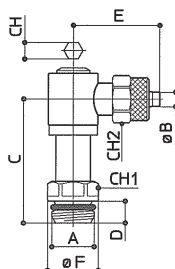

Typ	A	B	C	D	E	F	CH	CH1	CH2
C14L8047	1/8	5/3	30,5	5	22,5	14	4	10	8
C14L4047	1/4	5/3	32	6	24	14,3	4	10	12
C14L8067	1/8	6/4	30,5	5	26	14	4	10	12
C14L4067	1/4	6/4	32	6	24	14,3	4	10	14
C14L8087	1/8	8/6	30,5	5	26	14	4	10	14
C14L4087	1/4	8/6	32	6	28	14,3	4	10	16

T-Einschraubverschraubung drehbar mit Innensechskant

Baureihe C13

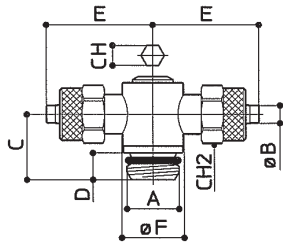

Typ	A	B	C	D	E	F	CH	CH2
C138047	1/8	5/3	13,5	5	22,5	14	4	8
C134047	1/4	5/3	15	6	24	14,3	4	12
C138067	1/8	6/4	13,5	5	26	14	4	12
C134067	1/4	6/4	15	6	24	14,3	4	14
C138087	1/8	8/6	13,5	5	26	14	4	14
C134087	1/4	8/6	15	6	28	14,3	4	16

T-Einschraubverschraubung drehbar mit Innensechskant, lang

Baureihe C13L

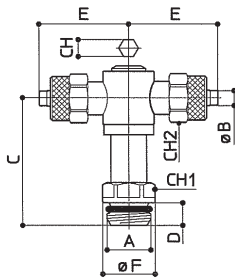

Typ	A	B	C	D	E	F	CH	CH1	CH2
C13L8047	1/8	5/3	30,5	5	22,5	14	4	10	8
C13L4047	1/4	5/3	32	6	24	14,3	4	10	12
C13L8067	1/8	6/4	30,5	5	26	14	4	10	12
C13L4067	1/4	6/4	32	6	24	14,3	4	10	14
C13L8087	1/8	8/6	30,5	5	26	14	4	10	14
C13L4087	1/4	8/6	32	6	28	14,3	4	10	16

L-Verschraubung

Baureihe C30

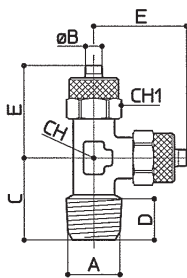

Typ	A	B	C	D	E	CH	CH1
C30505	M5	5/3	14,5	4	21,5	8	8
C30805	1/8	5/3	17	8	21,5	8	8
C30806	1/8	6/4	17	8	22,5	8	12
C30406	1/4	6/4	20	11	22,5	10	12
C30306	3/8	6/4	22,5	11	23,5	11	12
C30808	1/8	8/6	18	8	25	10	14
C30408	1/4	8/6	20	11	25	10	14
C30308	3/8	8/6	24	11	25	11	14
C30810	1/8	10/8	18,5	5	25,5	11	16
C30410	1/4	10/8	22	11	25	11	16
C30310	3/8	10/8	32,5	11	25,5	11	16
C30210	1/2	10/8	30	14	28	17	16
C30312	3/8	12/10	24,5	11	30	14	18
C30212	3/8	12/10	28	14	30	17	18
C30215	1/2	15/12,5	28	14	34	17	22

Winkel-Aufschraubverschraubung

Baureihe C19

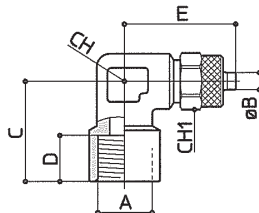

Typ	A	B	C	D	E	CH	CH1
C19805	1/8	5/3	19	8	21,5	10	8
C19806	1/8	6/4	20	8	23	10	12
C19406	1/4	6/4	25,5	11	26	13	12
C19808	1/8	8/6	20	8	23	10	14
C19408	1/4	8/6	25,5	11	26	13	14
C19410	1/4	10/8	25,5	11	26	13	16
C19312	3/8	12/10	28	11	30,5	17	18

Baureihe C18

T-Einschraubverschraubung

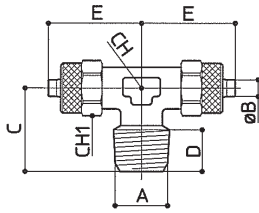

Typ	A	B	C	D	E	CH	CH1
C18505	M5	5/3	14,5	4	21,5	8	8
C18805	1/8	5/3	17	8	21,5	8	8
C18806	1/8	6/4	17	8	22	8	12
C18406	1/4	6/4	21	11	22,5	10	12
C18306	3/8	6/4	22,5	11	23,5	11	12
C18808	1/8	8/6	20	8	22,5	10	14
C18408	1/4	8/6	21	11	22,5	10	14
C18308	3/8	8/6	24	11	23,5	11	14
C18810	1/8	10/8	18/5	8	25,5	11	16
C18410	1/4	10/8	23	11	26	11	16
C18310	3/8	10/8	23	11	26,5	11	16
C18210	1/2	10/8	29	14	30	17	16
C18312	3/8	12/10	25	11	30	13	19
C18212	1/2	12/10	28	14	30	17	19
C18215	1/2	15/12,5	28	14	34	17	22

Baureihe C50

Gerader Verbinder

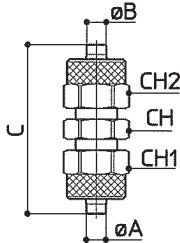

Typ	A	B	C	CH	CH1	CH2
C50005	5/3	5/3	28,5	8	8	8
C50006	6/4	6/4	34,5	12	12	12
C50008	8/6	8/6	35	14	14	14
C50010	10/8	10/8	38	14	16	16
C50012	12/10	12/10	42	17	19	19
C50015	15/12,5	15/12,5	45,5	22	22	22
C50608	8/6	6/4	35	14	14	12

Baureihe C60

Winkel-Verbinder

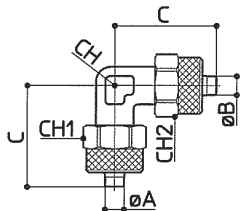

Typ	A	B	C	CH	CH1	CH2
C60005	5/3	5/3	18	9	9	9
C60006	6/4	6/4	21,5	8	12	12
C60008	8/6	8/6	22,5	10	14	14
C60010	10/8	10/8	25,5	11	16	16
C60012	12/10	12/10	29	13	19	19
C60015	15/12,5	15/12,5	34	17	22	22
C60608	8/6	6/4	22,5	10	14	12

Baureihe C70

T-Verbinder

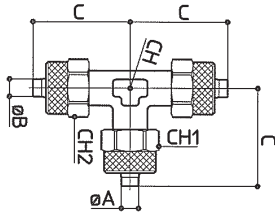

Typ	A	B	C	CH	CH1	CH2
C70005	5/3	5/3	21,5	8	8	8
C70006	6/4	6/4	22,5	8	12	12
C70008	8/6	8/6	22,5	10	14	14
C70010	10/8	10/8	25,5	11	16	16
C70012	12/10	12/10	29	13	19	19
C70015	15/12,5	15/12,5	34	17	22	22
C70608	8/6	6/4	22,5	10	14	12

Kreuz-Verbinder

Baureihe C26

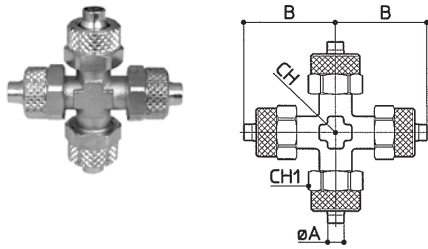

Typ	A	B	CH	CH1
C26005	5/3	21,5	8	8
C26006	6/4	22,5	8	12
C26008	8/6	22,5	10	14
C26010	10/8	25,5	11	16

Schottverschraubung

Baureihe C80

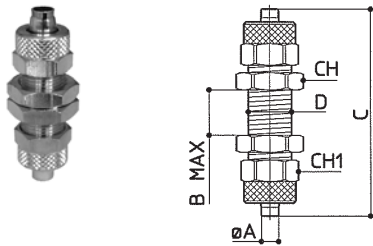

Typ	A	B	C	D	CH	CH1
C80005	5/3	8,5	40	M7x0,75	8	8
C80006	6/4	10,5	48	M10x1	14	12
C80008	8/6	12	50	M12x1	17	14
C80010	10/8	10	51	M14x1	17	16
C80012	12/10	10	52	M16x1	19	19
C80015	15/12,5	8,5	58	M20x1	24	22

Winkel-Ringanschluss

Baureihe C38

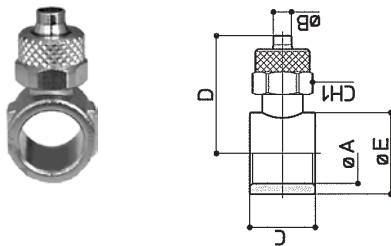

Typ	A	B	C	D	E	CH1
C38505	5,1-M5	5/3	9	17	9	8
C38805	9,8-1/8	5/3	14,5	22,5	14	8
C38506	5,1-M5	6/4	9	18	9	9
C38806	9,8-1/8	6/4	14,5	24	14	12
C38406	13,3-1/4	6/4	14,5	26	18	12
C38808	9,8-1/8	8/6	14,5	24	14	14
C38408	13,3-1/4	8/6	14,5	26	18	14
C38410	13,3-1/4	10/8	14,5	28	18	16

T-Ringanschluss

Baureihe C39

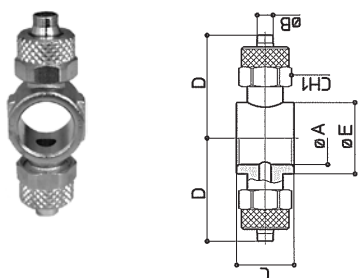

Typ	A	B	C	D	E	CH1
C39805	9,8-1/8	5/3	14,5	22,5	14	8
C39806	9,8-1/8	6/4	14,5	24	14	12
C39406	13,3-1/4	6/4	14,5	26	18	12
C39808	9,8-1/8	8/6	14,5	24	14	14
C39408	13,3-1/4	8/6	14,5	26	18	14
C39410	13,3-1/4	10/8	14,5	28	18	16

Überwurfmutter

Baureihe CDB

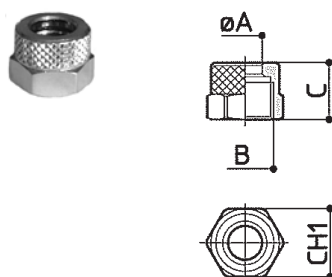

Typ	A	B	C	CH1
CDB005	5/3	M7x0,75	9	9
CDB006	6/4	M10x1	10	12
CDB008	8/6	M12x1	10	14
CDB010	10/8	M14x1	11,5	16
CDB012	12/10	M16x1	13	19
CDB015	15/12,5	M20x1	15,5	22