

Verbindungselemente

Verschraubungen aus Kunststoff

Baureihe GV

Seite 215



Baureihe WV

Seite 215



Baureihe SE

Seite 215



Baureihe SD

Seite 215



Baureihe TK

Seite 216



Baureihe SV

Seite 216



Baureihe S

Seite 216



Baureihe ST

Seite 216



Baureihe KL

Seite 216



Verschraubungen aus Kunststoff

Technische Anweisungen

Werkstoffe: POM
Höchstbetriebsdruck: 10 bar
Betriebstemperatur: -10°C bis +60°C



Wir freuen uns über Ihren Anruf!
Ihre Beratung zum Thema
Verschraubungen unter:

Mail: office@concomatic.at
Tel: +43 (0) 7221 20820

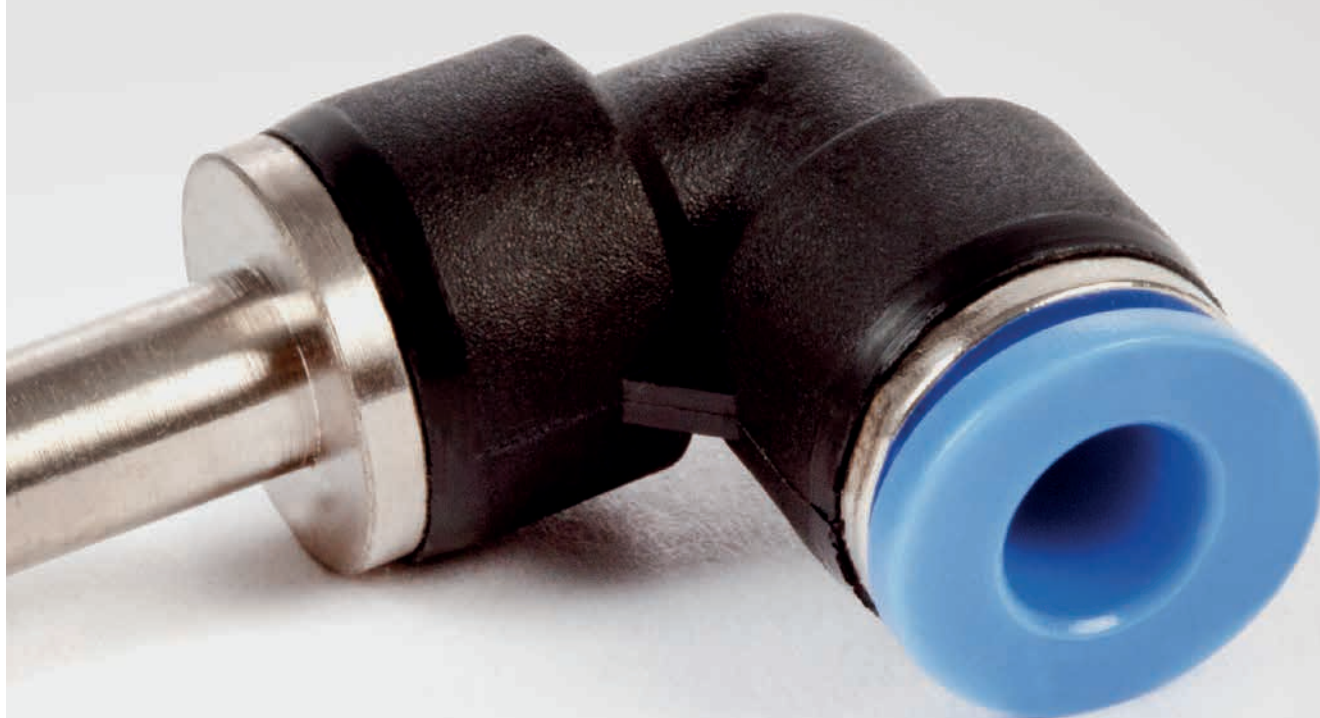

Gerade Einschraubverschraubung

Baureihe GV

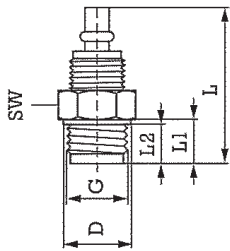

Typ	G	Schlauch		NW	SW	D	L	L1	L2
		AD	ID						
GV-0204K	1/8	6	4	3	13	11	28,0	7	6
GV-0206K	1/8	8	6	4,5	13	11	29,5	7	6
GV-0404K	1/4	6	4	3	17	14,5	31,0	9	8
GV-0406K	1/4	8	6	4,5	17	14,5	32,0	9	8
GV-0408K	1/4	10	8	6,5	17	14,5	34,0	9	8
GV-0409K	1/4	11,5	9	7	17	16	37,5	9	8
GV-0410K	1/4	12	9	7	17	16	37,5	9	8
GV-0606K	3/8	8	6	4,5	19	18,5	34,0	11	10
GV-0308K	3/8	10	8	6,5	19	18,5	35,5	11	10
GV-0309K	3/8	11,5	9	7	19	18,5	37,5	11	10
GV-0310K	3/8	12	9	7	19	18,5	37,5	11	10

Winkel-Einschraubverschraubung

Baureihe WV

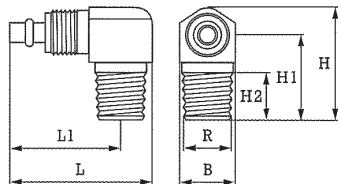

Typ	G	Schlauch		NW	B	L	L1	H	H1	H2
		AD	ID							
WV-0204K	1/8	6	4	3	11	29	23	22	16	8
WV-0206K	1/8	8	6	4,5	14	29	23	24	17	8
WV-0404K	1/4	6	4	3	14	32	24	25	19	11
WV-0406K	1/4	8	6	4,5	14	33	25	27	20	11
WV-0409K	1/4	11,5	9	6,8	17	36	28	33	23	13
WV-0410K	1/4	12	9	6,8	17	36	28	33	23	13
WV-0309K	3/8	11,5	9	6,8	17	36	28	33	23	13
WV-0310K	3/8	12	9	6,8	17	36	28	33	23	13

L-Schwenkverschraubung

Baureihe SE

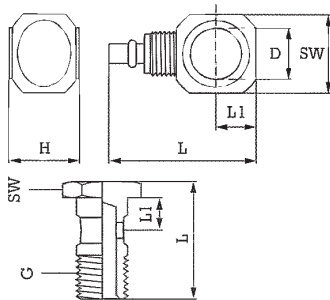

Typ	G	Schlauch		NW	SW	D	L	L1	L2	H
		AD	ID							
SE-0204K	1/8	6	4	3	16	10	31	8		16,5
SE-0206K	1/8	8	6	4,5	16	10	33	8		16,5
SE-0404K	1/4	6	4	3	20	13	35	10		16,5
SE-0406K	1/4	8	6	4,5	20	13	36,5	10		16,5

Hohlschraube										
	1/8					14		27	8	8
	1/4					17		29	10	8

T-Schwenkverschraubung

Baureihe SD

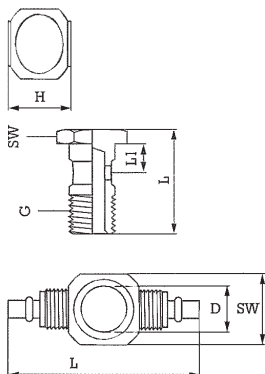

Typ	G	Schlauch		NW	SW	D	L	L1	L2	H
		AD	ID							
SD-0204K	1/8	6	4	3	16	10	47			16,5
SD-0206K	1/8	8	6	4,5	16	10	49			16,5
SD-0404K	1/4	6	4	3	20	13	51			16,5
SD-0406K	1/4	8	6	4,5	20	13	53			16,5

Hohlschraube										
	1/8					14		27	8	8
	1/4					17		29	10	8

Baureihe TK

T-Verbinder

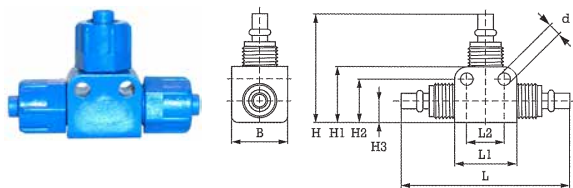

Typ	Schlauch		NW	L	L1	L2	B	d	H	H1	H2	H3
	AD	ID										
TK-0400K	6	4	3	52	20	12	15	4,3	32	16	12	6
TK-0600K	8	6	4,5	52	20	12	18	4,3	34	18	14	8
TK-0900K	11,5	9	6,8	63	25	15	22	4,3	40	21	16	8
GV-0406K	12	9	6,8	63	25	15	22	4,3	40	21	16	8

Baureihe SV

Gerader Verbinder

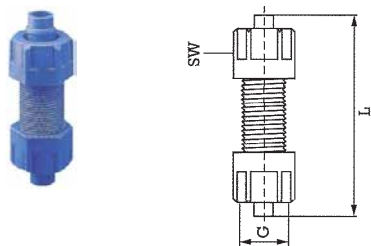

Typ	G	Schlauch		NW	L	SW	S
		AD	ID				
SV-0404K	M10x1	6	4	3	50	12	3
SV-0606K	M12x1	8	6	4,5	51	14	3
SV-0909K	M16x1	11,5	9	7	60	19	4,5
SV-1010K	M16x1	12	9	7	60	19	4,5

Baureihe S

Schottverschraubung

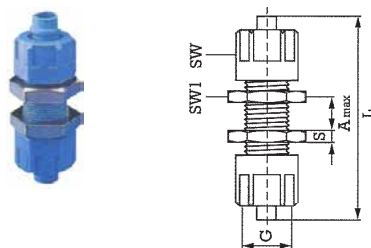

Typ	G	Schlauch		NW	L	A_max	SW	SW1	S
		AD	ID						
S-0004K	M10x1	6	4	3	50	10	12	13	3
S-0006K	M12x1	8	6	4,5	51	10	14	17	3
S-0009K	M16x1	11,5	9	7	60	10	19	19	4,5
S-0010K	M16x1	12	9	7	60	10	19	19	4,5

Baureihe ST

Schlauchstütze

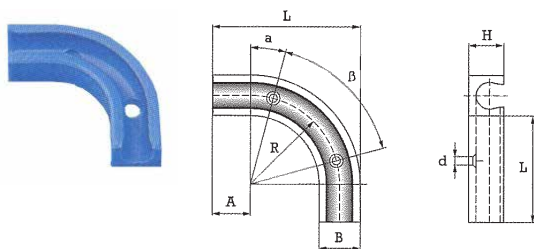

Typ	Schlauch AD	L	B	H	A	d	R	a	beta
ST-06K	8	38	13	10	10	3	21	15°	60°
ST-09K	11,5	58	16	13	15	3	33	15°	60°

Baureihe KL

Schlauch-Klemmleiste

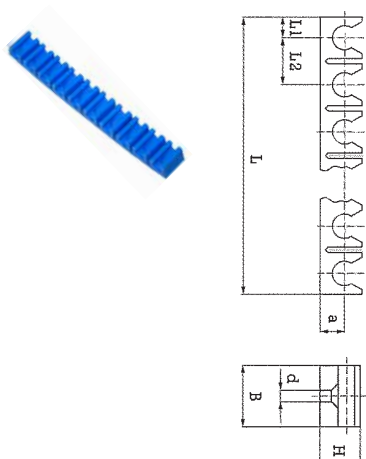

Typ	Schlauch AD	L	B	H	I1	I2	a	d	
									KL-05
KL-06	6	10	110	14	9	5,5	11	5,5	3
KL-08	8	10	140	15	12,5	6,4	14	7,5	2,8
KL-10	10	6	119	18	15	8,6	20,4	9	2,8
KL-11	11,5	6	118	18	16	8,6	20,4	10	2,8